

5580 SMART VIBRATION SIGNAL CONDITIONER AND SW5580 DUAL CHANNEL CONFIGURABLE SWITCH

Installation Manual

OVERVIEW



5580 Smart Vibration Signal Conditioner

The 5580 is a new generation DIN rail mounted Smart Vibration Signal Conditioner from Metrix. The SW5580 is like the 5580, but includes optional dry contacts or solid state relay contacts. They have been designed to accept signals from machine casing mounted velocity sensors, accelerometers or shaft observing proximity probe systems and produce a 4-20 mA output signal proportional to the measured variable and an amplified raw signal. It provides the user with a configurable signal input type for one or two independent channels plus the ability to scale output either to peak or RMS units. For each channel, a green LED indicates sensor and cable integrity. In the event of sensor failure, the LED changes to red and the output current is driven below 3.6 mA, thereby signaling a malfunction. A BNC connector gives access to the raw input signal for local analysis. A built-in 4-digit LCD display is used to display both dynamic input and 4-20 mA output signal. Isolation is provided between input, outputs and supply.



SW5580 Dual Channel Configurable Switch

Designed for ease of use, the USB interface is fitted for quick and easy configuration. Just connect a standard USB cable between the 5580, or SW5580, and your PC. Using our free configuration software, you can configure the device in the field to meet your application requirements. Use as a single or dual channel device.

INSTALLATION

The DIN rail mounting signal conditioner can be mounted in the Metrix Part #7595 explosion proof housing. For non-explosion proof applications, Metrix Part #7876 and Metrix Part #8172 weatherproof housings may be specified for this DIN rail mounting signal conditioner. For the best results, the 5580 or SW5580 should be installed within 1000 feet (300 m) of the transducer.

INSTALLATION CONSIDERATIONS

Many variables exist in transmitter installations (e.g. 5580 or SW5580) such as location, type of enclosure, proximity and type of other devices, type and length of wiring, etc.

In general, the 5580 or SW5580 should be located in a separate enclosure from electrical systems, which switch electrical power at large voltages or currents, such as motor controls. Grounded metal enclosures are much preferred to nonmetallic ones in areas where strong AC power or radio frequency (RF) fields are present, even on an intermittent basis. Possible sources of electrical interference are electrical motors and generators, SCR drives, motor contacts, RF heaters, engine ignition systems, handheld transceivers (walkie-talkies), cell phones, etc.

Handheld transceivers and cell phones are capable of interfering with the proper operation of the 5580 or SW5580, especially with the enclosure door open and the device held in close proximity to wiring. The RF filtering components in the transmitter protect against normally expected RF levels, but excessive levels can cause interference. It is good practice to keep operating RF sources as far away from electronic devices as possible. In severe cases a ferrite core (Metrix Part# 97007-006) may be required to be added on power or signal wiring. These commonly available devices are either snapped over the wiring or the wiring is looped several times through the device.

The 24VDC power supply must be connected to Channel 1 and not Channel 2. Channel 2 is reserved for the Reset functionality of the SW5580. Connecting power to Channel 2 will cause a problem with the device. In some installations, the 24VDC power source can have significant electrical noise present. Common sources of noise are battery chargers, unregulated power supplies and switching type power supplies. 24VDC relays and solenoids that are not protected with snubbing diodes or transient protectors will generate voltage transients that may interfere with the proper operation of the 5580 or SW5580. Ensure that the 24VDC power source is a regulated type and free from electrical noise under all conditions.

None of the wiring connected to the 5580 or SW5580 or other devices within the enclosure should, with the exception of the power supply wiring, be run in conduits or cable trays with plant power wiring or control relay and solenoid wiring. All inputs and outputs should be wired with shielded cables. Totally shielded (100% foil) cables are preferred to 90% braided type shielded cables. The shield should be continued to within 1 to 2 inches (25 to 50mm) of the 5580 or SW5580 terminals. The shield itself should be connected to the provided shield terminal. The shield connection should be as short as possible. Ensure that all shields are connected only at one end, preferably at the control cabinet. Alternate shield connections are possible such as to instrumentation grounds, etc. In general, connection of shields to earth grounds should be avoided except at one central earth grounding point for a complete system as “ground loops” may be created, which can introduce unwanted power frequency pickup.

SENSOR MALFUNCTION

The signal conditioners are provided with a sensor malfunction detector. In the event of an open circuit, the output current will drop below 3.6 mA and the LED turns red. The signal conditioners also detect incorrect polarity or shorted cable conditions.

WIRING



WARNING: Do not apply power to Channel 2 to avoid damage. Only apply power to Channel 1.

SENSOR (Signal Input): Connect the transducer or charge amp output cable leads to these terminals. If the transducer is a self-generating velocity pickup, polarity is arbitrary unless the signal polarity at the SIG OUT BNC connector is important for analysis purposes. If proximity sensor, accelerometer, piezoelectric velocity transducer or charge amp is used, correct polarity must be observed.

4-20 mA (Current Source Output): Wire the receiving device to these terminals, observing correct polarity. The total resistance of the receiver input and wiring must be between 25 and 600 ohms, up to 2000 meters (6500 ft).

SIG OUT (Signal Output): This signal is identical to the input signal and is buffered for driving remote vibration analysis instruments. The terminal block terminals can send a signal up to 300 meters (1000 ft). The BNC can send the raw signal 5 meters (16 ft).

24 VDC (Power Input - Channel 1 only): For best results, the sum of the DC power voltage, plus or minus AC ripple and noise, should be within 20 to 30 volts. Do not apply power to Channel 2.

In Class I, Div 2, Groups A, B, C & D locations, the signal conditioner may be wired in accordance with page 4 or drawing 9031 for the 5580 Smart Signal Conditioner and page 5 or drawing for the SW5580 Dual Channel Configurable Switch.

If the sensors going to the 5580/SW5580 are in a Class I, Div 1 or Zone 0 or 1 area then barriers will be required in accordance with the approved sensor drawings.

The pin-out for the 5580 wiring diagram is shown below:

A/V – Accelerometer/Velocity Sensor

PS – Proximity Signal

PC – Proximity Common

PP – Proximity Power

NC – No Connection

PIN	Channel 1		Channel 2	
1	4-20mA +		4-20mA +	
2	4-20mA -		4-20mA -	
3	Raw signal out +		Raw signal out +	
4	Raw signal out -		Raw signal out -	
5	NC	PS	NC	PS
6	A/V +	PC	A/V +	PC
7	A/V -	PP	A/V -	PP
8	+	+24VDC	NC	
9	-		NC	

WIRING CONTINUED

The SW5580 Dual Channel Configurable Switch comes with either Mechanical (Dry Contacts) Relays (4 SPDT 240/120 VAC resistive load, or 5A 24 VDC resistive load) or Solid State Relays (4 SPST, 100 mA, 120 VAC, or 24 VDC).

The pin-out for the SW5580 wiring diagram is show below

PIN	Channel 1		Channel 2	
1	4-20mA +		4-20mA +	
2	4-20mA -		4-20mA -	
3	Raw signal out +		Raw signal out +	
4	Raw signal out -		Raw signal out -	
5	NC	PS	NC	PS
6	A/V +	PC	A/V +	PC
7	A/V -	PP	A/V -	PP
8	+	+24VDC	+	Reset
9	-		-	
	Dry Contacts	Solid State	Dry Contacts	Solid State
10	Alert N.O.	Alert +	Alert N.O.	Alert +
11	Alert N.C.	Not Used	Alert N.C.	Not Used
12	Alert Common	Alert -	Alert Common	Alert -
13	Danger N.O.	Danger +	Danger N.O.	Danger +
14	Danger N.C.	Not Used	Danger N.C.	Not Used
15	Danger Common	Danger -	Danger Common	Danger -

A/V – Accelerometer/Velocity Sensor

PS – Proximity Signal

PC – Proximity Common

PP – Proximity Power

NC – No Connection

Reset – For Latching Alarms

N.C. - Normally Closed

N.O. - Normally Open

WEIGHT & DIMENSIONS

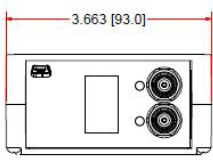

Weight: 0.8 lbs (0.36 kg)

Maximum Power: 3.2W (5580), 4.0W (SW5580)

Recommended Wire Gauge: 0.8 mm² (18 AWG),

Allowed: 0.2 to 1.3 mm² (16 to 24 AWG)

Relay Wiring: Solid State Relays - Allowed: 0.2 to 1.3 mm² (16 to 24 AWG), Electromechanical Relays - Allowed: 1.3mm² (16 AWG)

Mounting: 35mm DIN rail mounting clip

Temperature Limits: 5580: -40° C to +85° C (-40° F to +185° F)

SW5580: -40° C to +65° C (-40° F to +149° F)

Casing Material: ABS PA765 Durable Plastic

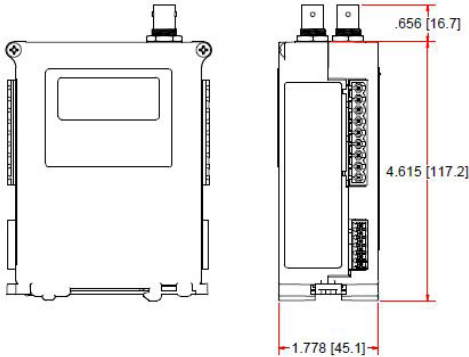

ELECTROMAGNETIC COMPATIBILITY (EMC)

EMC TEST REPORT
(FULL COMPLIANCE)

Report Number: 104414010DAL-001 Project Number: G104414010

Report Issue Date: August 20, 2020

5580 Smart Vibration Signal Conditioner
SW5580 Dual Channel Configurable Switch

Standards:

CISPR 11:2009Ed.5+A1

Industrial, Scientific and Medical Equipment – Radio Frequency Disturbance Characteristics - Limits and Methods of Measurement

IEC 61000-4-4 Ed. 2.1:2011

Electromagnetic compatibility (EMC) - Part 4-4: Testing and measurement techniques - Electrical fast transient/burst immunity test

IEC 61000-4-6 Ed.3: 2008

Electromagnetic compatibility (EMC) - Part 4-6: Testing and measurement techniques - Immunity to conducted disturbances, induced by radio-frequency fields

POSSIBLE MEASUREMENTS¹

The 5580 and SW5580 support most commercially available acceleration, velocity, and proximity sensors, including the provision of any necessary sensor power. A single +24Vdc connection powers the device, its 4-20mA output(s), and its connected sensor(s) –including the -24Vdc power required by proximity transducers and the constant current required by IEPE accelerometers and piezo-velocity sensors.

- Shaft-relative radial vibration
- Shaft axial position (Thrust Measurements)
- Casing vibration (radial or axial)
- Shaft rotative speed
- Reciprocating compressor rod drop
- Reciprocating compressor rod position
- Reciprocating compressor crosshead acceleration
- Reciprocating machine impact measurements
- Reciprocating compressor frame vibration
- Dual Path measurements (two channel mode only)
 - One accelerometer input may generate an accelerometer output and an integrated velocity output
 - One accelerometer input may generate an accelerometer output and an impact output
 - One velocity input may generate a vibration output and an integrated position output
 - One proximity input may generate a position output (gap) and a vibration output
- Dual Channel measurements (two channel mode only)
 - Two acceleration inputs generates two acceleration outputs
 - Two acceleration inputs generates two impact outputs
 - One acceleration and one velocity input generates one acceleration and one velocity output
 - Two velocity inputs generates two velocity outputs
 - One velocity input and one proximity input generates one velocity and one proximity output (proximity output can be vibration, position or speed)

Note 1: See Datasheet for input and scale options

MINI-USB CONNECTION





Designed for ease of use, the mini-USB interface is fitted for quick and easy configuration. Just connect a standard USB to mini-USB cable between the 5580 or SW5580 and a PC. Using the free configuration software, one may configure the device in the field to meet application requirements. The mini-USB port supports standard USB connections of up to 5m (16 feet).

DISPLAY SCREEN

A built-in 4-line alpha-numeric LCD display is used to display both dynamic input and 4-20 mA output signals. The device's LCD display ensures that readings are available locally rather than only at the HMI for the PLC, DCS, or other controller. Both channels are displayed continuously and simultaneously to include the channel number, the 4-20mA output value, the measured value, and the associated engineering units.

LED STATUS

For each channel, a green LED indicates sensor and cable integrity. In the event of sensor failure, the LED changes to red and the output current is driven below 3.6 mA, thereby signaling a malfunction. The alarm status is indicated by the LED flashing yellow for Alert and flashing red for Danger.

Color		5580	SW5580
Solid Green		Channel OK	Channel OK with no alarms
Flashing Yellow		N/A	Channel OK but in ALERT
Flashing Red		N/A	Channel OK but in DANGER
Solid Red		Channel NOT OK	Channel NOT OK
Off		Device unpowered	

BNC

Conventional BNC connectors for each channel are provided for easy connection to portable instruments such as data collectors, DVMs, and analyzers where the cable length does not exceed 16 feet (5 meters). These outputs are isolated from the 4-20mA outputs to ensure connection of external devices do not compromise the integrity of the monitoring or protective functions.

AMPLIFIED BUFFERED OUTPUTS

When devices are mounted in junction boxes at the machine, it can be inconvenient to open the box to connect portable instruments. In prior generations of Metrix devices, and on most commercially available monitors, the buffered outputs are not suitable for wiring runs exceeding 5-10 meters without use of an external amplifier to drive the raw signals over long distances. The 5580 / SW5580 overcomes this limitation by employing integrated signal amplification, allowing buffered output signals to be driven up to 1000 feet (300 meters). The amplified signal is available at wiring terminals and is intended for permanent connection to remote patch panels or other condition monitoring systems.

NOT OK ANNUNCIATION

In addition to NOT OK status annunciation via the device's LEDs, the current loop (4-20mA) output for each channel will clamp to a value below 4mA, ensuring that a NOT OK condition can be distinguished from other conditions.

Condition	4-20mA output
No Power	0 mA
NOT OK	3.6 mA
OK, bottom scale	4 mA
OK, mid-range	Between 4 and 20 mA
OK, full scale	20 mA

ALERT AND DANGER RELAYS (SW5580 ONLY)

For the SW model, four (4) relays are provided, two for each channel. This allows ALERT and DANGER to be separately annunciated for each channel. The relays can be configured for latching or non-latching operation, normally energized or normally de-energized. Normally Open (N.O.) and Normally Closed (N.C.) wiring terminals are provided. Users can choose from either solid-state (SPST) or electromechanical (SPDT) relays at time of ordering. Solid-state relays are typically used for providing logic-level alarm status to controllers and other devices. Electromechanical relays are typically used to switch interposing relays, fuel valve solenoids, or other trip devices as part of the machine's control where the signal being switched is larger than a logic-level voltage. An example of the RELAYS configuration tab within the 5580 Signal Conditioner Configuration Software is shown below.

METRIX Dual Channel Smart Signal Conditioner

HOME RELAYS IMPACT ROD DROP ADVANCED SETTINGS

Channel 1

Alert Level: 2.5 g. pk
 Alert Delay: 3 sec
 Alert Latching Mode: Non-Latching Mode
 Danger Level: 5 g. pk
 Danger Delay: 3 sec
 Danger Latching Mode: Non-Latching Mode
 Active/Passive: Active (Fail-Safe)

Channel 2

Alert Level: N/A
 Alert Delay: N/A
 Alert Latching Mode: N/A
 Danger Level: N/A
 Danger Delay: N/A
 Danger Latching Mode: N/A
 Active/Passive: N/A

Relay Settings

Time Delay

Channel 1 - Alert Level: 2.5 g. pk 3 seconds Latch Mode
 Channel 1 - Danger Level: 5 g. pk 3 seconds Latch Mode
 Channel 2 - Alert Level: seconds Latch Mode
 Channel 2 - Danger Level: seconds Latch Mode

* Active (Fail-Safe) ○ Passive (Not Fail-Safe)

NOTES:

- Engineering units are the same as selected for the full-scale range.
- With regard to Relays, "Fail-Safe" means the Relay's state is the same as in the Alarm Condition, Open or Shut, when the Relay is not powered.
- Normal State, Normally Open or Normally Shut, refers to a Relay's state when not powered, de-energized, or Short State.
- Normally Open Relay will present an open circuit at the terminals of the Relay when not powered (de-energized).
- Normally Closed Relay will present a short circuit at the terminals of the Relay when not powered (de-energized).
- Please refer to the User Manual for more specific information on relay operation.

*Fail-Safe modes are required for SIL ratings.

Version: 1.03.10

Additional and comprehensive notes related to relay configuration are as follows:

1. Engineering units are the same as selected for the full-scale range.
2. With regard to Relays, "Fail Safe*" means the Relay's state is the same as in the Alarm Condition, Open or Shut, when the Relay is not powered.
3. Normal State, Normally Open or Normally Shut, refers to a Relay's not powered, de-energized, or Shelf State.
4. Normally Open Relay will present an open circuit at the terminals of the Relay when not powered (de-energized).
5. Normally Closed Relay will present a short circuit at the terminals of the Relay when not powered (de-energized).
6. "Active (Fail Safe)" applies power to the Relay and forces the Relay to change state in a non-Alarm condition. In an Alarm condition, or if Power is lost, the relay changes to the de-energized "Shelf State". This is Fail Safe*.
7. "Passive (Not Fail Safe)" does not apply power to the Relay in a non-Alarm condition. In an Alarm condition the Relay is energized to change state. On a loss of power the Relay reverts back to the de-energized non-alarm "Shelf State", even if an Alarm is present, so therefore, the Relay is Not Fail Safe.
8. Example: If using Mechanical Relays, and the Normally Closed terminals selected, with a non-Alarm condition, but the SW5580 in powered on, the Mechanical Relays will Open with "Active (Fail Safe)" selected. If an Alarm is exceeded, or if power is lost, the Relay closes – Fail Safe*.
9. Example: If using the Solid State Relays, and the Normally Open terminals are selected, with a non-Alarm condition, but the SW5580 in powered on, the Solid State Relays will shut with "Active (Fail Safe)" selected. If an Alarm is exceeded, or if power is lost, the Relay opens – Fail Safe*.

*Fail-safe modes are required for SIL ratings.

SHUTDOWN VERSUS ALARMING CONSIDERATIONS

Two levels of setpoints are available in the SW5580: Alert (pre-shutdown) and Danger (shutdown). When the 5580 is used instead of the SW5580, the alarms are implemented in a PLC, DCS, or other control platform. Where alarm settings are available from the OEM, those levels should be implemented by default and then adjusted over time as process, operating conditions, and experience dictate. Although there can be numerous, vibration and position measurements associated with rotating and reciprocating machines, most industry standards suggest that only a small number be used for machinery protection (i.e., auto-shutdown) purposes with the rest being used for condition monitoring purposes.

REMOTE RESET

Latching-type alarms and relays can be reset remotely by using the reset terminal on the device. Using “Reset” will release all cleared latched alarms.

REMOVABLE WIRING TERMINAL BLOCKS



Note: The 24VDC power supply must be connected to Channel 1 and not Channel 2.

For ease-of-maintenance, wiring terminals are removable. Four separate wiring terminal blocks are provided, two on top and two on bottom as follows:

Location	Connector #	Connections
Top	1	Channel 1 - I/O and Power
	2	Channel 1 – relays*
Bottom	3	Channel 2 - I/O and Reset*
	4	Channel 2 – relays*

* only present on SW5580

HAZARDOUS AREA APPROVALS

AREA	5580	SW5580
North America	CLASS I, DIVISION 2, GROUPS A, B, C & D, CLASS I, ZONE 2, AEx ec nC IIC T4 Gc -40°C ≤Ta≤ +85°C ETL20CA104377470X Increased Safety	CLASS I, DIVISION 2, GROUPS A, B, C & D, CLASS I, ZONE 2, AEx ec nC IIC T4 Gc -40°C ≤Ta≤ +65°C ETL20CA104377470X Increased Safety
International ATEX/IECEX/ UKEX	 Ex ec nC IIC T4 Gc II 3 G -40°C ≤Ta≤ +85°C ITS-I21ATEX30380X IECEX ETL 21.0036X ITS21UKEX0213X Increased Safety	 Ex ec nC IIC T4 Gc II 3 G -40°C ≤Ta≤ +65°C ITS-I21ATEX30380X IECEX ETL 21.0036X ITS21UKEX0213X Increased Safety

WARNING – EXPLOSION HAZARD. DO NOT CONNECT OR DISCONNECT WHEN ENERGIZED.

AVERTISSEMENT - RISQUE D'EXPLOSION. NE PAS CONNECTER OU DÉCONNECTER UNE FOIS SOUS TENSION.

SPECIAL CONDITIONS FOR SAFE USE

- The 24VDC power supply must be connected to Channel 1 and not Channel 2.
- The maximum internal equipment surface temperature measured according test conducted per Clause 26.5.1 IEC/EN/UL/CSA 60079-0 Standard was 91.84°C (@ 65°C ambient) for SW5580 model and 111.84°C (@ 85°C ambient) for 5580 model. End user must verify that the enclosure in which this equipment is installed is suitably rated for service per these temperatures.
- Equipment shall be installed in an Ex certified enclosure that is tool secured which provides a minimum ingress protection of IP54. The equipment must be mounted on a vertical or horizontal rail within the enclosure.
- Coaxial connections provided for the access to the input signal reference circuit ground. Care shall be taken whilst installing the equipment to ensure a dielectric isolation of 500Vrms is maintained.
- The equipment shall only be used in an area of at least pollution degree 2, as defined in IEC 60664-1.
- Equipment shall be installed in an Ex certified tool secured enclosure which provides a minimum ingress protection of IP54.
- Transient protection shall be provided on the supply to limit transients not to exceed 33.6VDC.

POWER SUPPLY CONSIDERATIONS

A 24VDC power supply must be connected to Channel 1 only. The power supply can be selected from any reputable provider and for added reliability, redundant schemes can be used if desired. When selecting a power supply, use the following sizing considerations for each 5580 / SW5580.

	5580	SW5580
Max Power Consumption	4.4W	5.2W

The table above assumes worst-case conditions where all relays are energized, all transducers are accelerometers consuming a maximum power of 20mA @ 24V each, all recorder outputs are at full scale of 20 mA, and all buffered outputs are driving the maximum allowable length of field wiring at maximum signal amplitude.

ENCLOSURE CONSIDERATIONS

When mounting the system at the machine, a suitable enclosure is recommended to protect the electronics from the elements. Additionally, an enclosure may be mandatory for installation in NRTL Class 1 Div 2, IECEx and ATEX Zone 2 hazardous environments. Where local display of status and current values is required, select an enclosure with a window.

When sizing the enclosure, refer to the 5580 / SW5580 datasheet (doc #1874512) for heat dissipation requirements to ensure adequate airflow and that temperature rise does not subject the devices to operation outside of maximum ratings. Make certain to include the power supply in these calculations as well. Consult the factory or your local Metrix sales professional for assistance, including installation and project advice.

REV. CHANGE RECORDS

A. RELEASE

MODEL NUMBER: SW5550

DATE: 07/27/20

ISSUE NO.: 3

ISSUE DATE: 07/27/20

ISSUE BY: [Signature]

APPROVED BY: [Signature]

INSTALLATION CLASS: 1, DIV. 2, GRES A-D

EX: SW5550 SMART SWITCH

ORDER NO.: 1899690

DATE: 11/21/18

DATE OF SCALE ORDER: []

LOCATION: []

SCALE: []

NOTE: (UNLESS OTHERWISE SPECIFIED)

1. ALL ELECTRICAL CONNECTIONS SHALL BE MADE IN ACCORDANCE WITH THE NATIONAL ELECTRICAL CODE (NEC) FOR THE LOCAL JURISDICTION. THE WIRING SHALL BE MADE IN ACCORDANCE WITH THE NATIONAL ELECTRICAL CODE (NEC) FOR THE LOCAL JURISDICTION.

2. THE INSTRUMENT SHALL BE INSTALLED IN A LOCATION WHERE IT IS PROTECTED FROM EXCESSIVE TEMPERATURE, VIBRATION, AND EXCESSIVE HUMIDITY. THE INSTRUMENT SHALL BE PROTECTED FROM EXCESSIVE TEMPERATURE, VIBRATION, AND EXCESSIVE HUMIDITY.

3. THE INSTRUMENT SHALL BE PROTECTED FROM EXCESSIVE TEMPERATURE, VIBRATION, AND EXCESSIVE HUMIDITY.

4. THE INSTRUMENT SHALL BE PROTECTED FROM EXCESSIVE TEMPERATURE, VIBRATION, AND EXCESSIVE HUMIDITY.

5. THE INSTRUMENT SHALL BE PROTECTED FROM EXCESSIVE TEMPERATURE, VIBRATION, AND EXCESSIVE HUMIDITY.

6. THE INSTRUMENT SHALL BE PROTECTED FROM EXCESSIVE TEMPERATURE, VIBRATION, AND EXCESSIVE HUMIDITY.

7. THE INSTRUMENT SHALL BE PROTECTED FROM EXCESSIVE TEMPERATURE, VIBRATION, AND EXCESSIVE HUMIDITY.

8. THE INSTRUMENT SHALL BE PROTECTED FROM EXCESSIVE TEMPERATURE, VIBRATION, AND EXCESSIVE HUMIDITY.

9. THE INSTRUMENT SHALL BE PROTECTED FROM EXCESSIVE TEMPERATURE, VIBRATION, AND EXCESSIVE HUMIDITY.

10. THE INSTRUMENT SHALL BE PROTECTED FROM EXCESSIVE TEMPERATURE, VIBRATION, AND EXCESSIVE HUMIDITY.

11. THE INSTRUMENT SHALL BE PROTECTED FROM EXCESSIVE TEMPERATURE, VIBRATION, AND EXCESSIVE HUMIDITY.

12. THE INSTRUMENT SHALL BE PROTECTED FROM EXCESSIVE TEMPERATURE, VIBRATION, AND EXCESSIVE HUMIDITY.

13. THE INSTRUMENT SHALL BE PROTECTED FROM EXCESSIVE TEMPERATURE, VIBRATION, AND EXCESSIVE HUMIDITY.

14. THE INSTRUMENT SHALL BE PROTECTED FROM EXCESSIVE TEMPERATURE, VIBRATION, AND EXCESSIVE HUMIDITY.

15. THE INSTRUMENT SHALL BE PROTECTED FROM EXCESSIVE TEMPERATURE, VIBRATION, AND EXCESSIVE HUMIDITY.

16. THE INSTRUMENT SHALL BE PROTECTED FROM EXCESSIVE TEMPERATURE, VIBRATION, AND EXCESSIVE HUMIDITY.

17. THE INSTRUMENT SHALL BE PROTECTED FROM EXCESSIVE TEMPERATURE, VIBRATION, AND EXCESSIVE HUMIDITY.

18. THE INSTRUMENT SHALL BE PROTECTED FROM EXCESSIVE TEMPERATURE, VIBRATION, AND EXCESSIVE HUMIDITY.

19. THE INSTRUMENT SHALL BE PROTECTED FROM EXCESSIVE TEMPERATURE, VIBRATION, AND EXCESSIVE HUMIDITY.

20. THE INSTRUMENT SHALL BE PROTECTED FROM EXCESSIVE TEMPERATURE, VIBRATION, AND EXCESSIVE HUMIDITY.

21. THE INSTRUMENT SHALL BE PROTECTED FROM EXCESSIVE TEMPERATURE, VIBRATION, AND EXCESSIVE HUMIDITY.

22. THE INSTRUMENT SHALL BE PROTECTED FROM EXCESSIVE TEMPERATURE, VIBRATION, AND EXCESSIVE HUMIDITY.

23. THE INSTRUMENT SHALL BE PROTECTED FROM EXCESSIVE TEMPERATURE, VIBRATION, AND EXCESSIVE HUMIDITY.

24. THE INSTRUMENT SHALL BE PROTECTED FROM EXCESSIVE TEMPERATURE, VIBRATION, AND EXCESSIVE HUMIDITY.

25. THE INSTRUMENT SHALL BE PROTECTED FROM EXCESSIVE TEMPERATURE, VIBRATION, AND EXCESSIVE HUMIDITY.

26. THE INSTRUMENT SHALL BE PROTECTED FROM EXCESSIVE TEMPERATURE, VIBRATION, AND EXCESSIVE HUMIDITY.

27. THE INSTRUMENT SHALL BE PROTECTED FROM EXCESSIVE TEMPERATURE, VIBRATION, AND EXCESSIVE HUMIDITY.

28. THE INSTRUMENT SHALL BE PROTECTED FROM EXCESSIVE TEMPERATURE, VIBRATION, AND EXCESSIVE HUMIDITY.

29. THE INSTRUMENT SHALL BE PROTECTED FROM EXCESSIVE TEMPERATURE, VIBRATION, AND EXCESSIVE HUMIDITY.

30. THE INSTRUMENT SHALL BE PROTECTED FROM EXCESSIVE TEMPERATURE, VIBRATION, AND EXCESSIVE HUMIDITY.

31. THE INSTRUMENT SHALL BE PROTECTED FROM EXCESSIVE TEMPERATURE, VIBRATION, AND EXCESSIVE HUMIDITY.

32. THE INSTRUMENT SHALL BE PROTECTED FROM EXCESSIVE TEMPERATURE, VIBRATION, AND EXCESSIVE HUMIDITY.

33. THE INSTRUMENT SHALL BE PROTECTED FROM EXCESSIVE TEMPERATURE, VIBRATION, AND EXCESSIVE HUMIDITY.

34. THE INSTRUMENT SHALL BE PROTECTED FROM EXCESSIVE TEMPERATURE, VIBRATION, AND EXCESSIVE HUMIDITY.

35. THE INSTRUMENT SHALL BE PROTECTED FROM EXCESSIVE TEMPERATURE, VIBRATION, AND EXCESSIVE HUMIDITY.

36. THE INSTRUMENT SHALL BE PROTECTED FROM EXCESSIVE TEMPERATURE, VIBRATION, AND EXCESSIVE HUMIDITY.

37. THE INSTRUMENT SHALL BE PROTECTED FROM EXCESSIVE TEMPERATURE, VIBRATION, AND EXCESSIVE HUMIDITY.

38. THE INSTRUMENT SHALL BE PROTECTED FROM EXCESSIVE TEMPERATURE, VIBRATION, AND EXCESSIVE HUMIDITY.

39. THE INSTRUMENT SHALL BE PROTECTED FROM EXCESSIVE TEMPERATURE, VIBRATION, AND EXCESSIVE HUMIDITY.

40. THE INSTRUMENT SHALL BE PROTECTED FROM EXCESSIVE TEMPERATURE, VIBRATION, AND EXCESSIVE HUMIDITY.

41. THE INSTRUMENT SHALL BE PROTECTED FROM EXCESSIVE TEMPERATURE, VIBRATION, AND EXCESSIVE HUMIDITY.

42. THE INSTRUMENT SHALL BE PROTECTED FROM EXCESSIVE TEMPERATURE, VIBRATION, AND EXCESSIVE HUMIDITY.

43. THE INSTRUMENT SHALL BE PROTECTED FROM EXCESSIVE TEMPERATURE, VIBRATION, AND EXCESSIVE HUMIDITY.

44. THE INSTRUMENT SHALL BE PROTECTED FROM EXCESSIVE TEMPERATURE, VIBRATION, AND EXCESSIVE HUMIDITY.

45. THE INSTRUMENT SHALL BE PROTECTED FROM EXCESSIVE TEMPERATURE, VIBRATION, AND EXCESSIVE HUMIDITY.

46. THE INSTRUMENT SHALL BE PROTECTED FROM EXCESSIVE TEMPERATURE, VIBRATION, AND EXCESSIVE HUMIDITY.

47. THE INSTRUMENT SHALL BE PROTECTED FROM EXCESSIVE TEMPERATURE, VIBRATION, AND EXCESSIVE HUMIDITY.

48. THE INSTRUMENT SHALL BE PROTECTED FROM EXCESSIVE TEMPERATURE, VIBRATION, AND EXCESSIVE HUMIDITY.

49. THE INSTRUMENT SHALL BE PROTECTED FROM EXCESSIVE TEMPERATURE, VIBRATION, AND EXCESSIVE HUMIDITY.

50. THE INSTRUMENT SHALL BE PROTECTED FROM EXCESSIVE TEMPERATURE, VIBRATION, AND EXCESSIVE HUMIDITY.

VELOCITY TRANSDUCER
METRIX, 5475C, 4000
GEC 4" x 1"

ACCELEROMETER OR VELOCITY TRANSDUCER
METRIX, 548000-XXX
548000-XXX
OR OTHER SUITABLE QUALIFIED TRANSDUCER

COMMON

EXP. MEAN

THIS DOCUMENT AND ALL INFORMATION HEREON IS THE PROPERTY OF METRIX INSTRUMENT CO., INC. (METRIX). IT IS TO BE KEPT IN CONFIDENTIALITY AND NOT BE REPRODUCED OR TRANSMITTED IN ANY FORM OR BY ANY MEANS, ELECTRONIC OR MECHANICAL, INCLUDING PHOTOCOPYING, RECORDING, OR BY ANY INFORMATION STORAGE AND RETRIEVAL SYSTEM. METRIX AND THE METRIX LOGO ARE TRADEMARKS AND REGISTERED PATENT RIGHTS OF METRIX INSTRUMENT CO., INC. ALL RIGHTS RESERVED. THIS DOCUMENT IS NOT BEING RETURNED TO THE CUSTOMER. ALL INFORMATION HEREON IS SUBJECT TO CHANGE WITHOUT NOTICE. SURFACE FINISH MUST BE RETURNED UPON REQUEST.

SURFACE FINISH: []

Doc# 1874512 • REV C • March 2022 Page 13 of 16

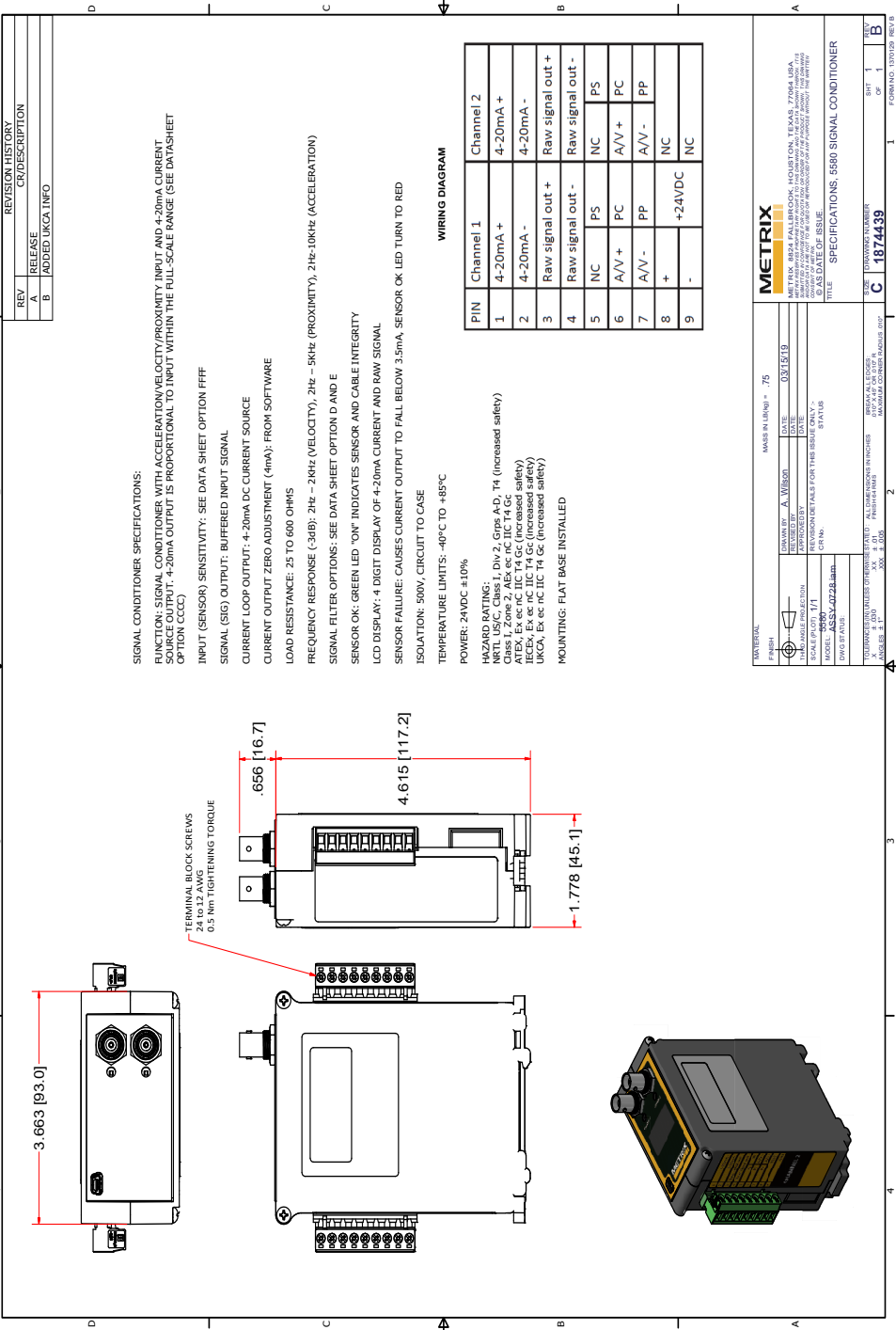

REVISION HISTORY	
REV.	DESCRIPTION
A	RELEASE
B	ADDED UKCA INFO

SIGNAL CONDITIONER SPECIFICATIONS:

FUNCTION: SIGNAL CONDITIONER WITH ACCELERATION/VELOCITY/PROXIMITY INPUT AND 4-20mA CURRENT OUTPUT. 4-20mA OUTPUT IS PROPORTIONAL TO INPUT WITHIN THE FULL-SCALE RANGE (SEE DATASHEET OPTION CCCC)

INPUT (SENSOR) SENSITIVITY: SEE DATA SHEET OPTION FFF

SIGNAL (SIG) OUTPUT: BUFFERED INPUT SIGNAL

CURRENT LOOP OUTPUT: 4-20mA DC CURRENT SOURCE

CURRENT OUTPUT ZERO ADJUSTMENT (4mA): FROM SOFTWARE

LOAD RESISTANCE: 25 TO 600 OHMS

FREQUENCY RESPONSE (-3dB): 2Hz - 2KHz (VELOCITY), 2Hz - 5KHz (PROXIMITY), 2Hz-10KHz (ACCELERATION)

SIGNAL FILTER OPTIONS: SEE DATA SHEET OPTION D AND E

SENSOR OK: GREEN LED "OK" INDICATES SENSOR AND CABLE INTEGRITY

LCD DISPLAY: 4 DIGIT DISPLAY OF 4-20mA CURRENT AND RAW SIGNAL

SENSOR FAILURE: CAUSES CURRENT OUTPUT TO FALL BELOW 3.5mA. SENSOR OK LED TURN TO RED

ISOLATION: 500V, CIRCUIT TO CASE

TEMPERATURE LIMITS: -40°C TO +85°C

POWER: 24VDC ±10%

HAZARD RATINGS:

NRTL US/CA: Class I, Div 2, Gyps A-D, T4 (increased safety)
 Class I, Zone 2, AEx ec IIC T4 Gc
 T4 Gc, Ex ec IIC T4 Gc (increased safety)
 IECEx: Ex ec IIC T4 Gc
 UKCA, Ex ec IIC T4 Gc (increased safety)

MOUNTING: FLAT BASE INSTALLED

WIRING DIAGRAM

PIN	Channel 1	Channel 2
1	4-20mA +	4-20mA +
2	4-20mA -	4-20mA -
3	Raw signal out +	Raw signal out +
4	Raw signal out -	Raw signal out -
5	NC	PS
6	A/V +	PC
7	A/V -	PP
8	+	NC
9	-	+24VDC

METRIX
 METRIX, 8005 FALLS CHURCH, VIRGINIA, USA, 22048 USA
 1-800-828-0303 METRIX.COM
 © 2022 METRIX. ALL RIGHTS RESERVED. METRIX IS A REGISTERED TRADEMARK OF METRIX CORPORATION. THE METRIX LOGO IS A TRADEMARK OF METRIX CORPORATION. ALL OTHER TRADEMARKS ARE THE PROPERTY OF THEIR RESPECTIVE OWNERS.

DATE OF ISSUE: 03/15/19
 DRAWN BY: A. WILSON
 CHECKED BY: A. WILSON
 SCALE: 1:1
 MODEL: 5680-0020-0000
 DIV: 07A108

MADE IN LENGTH = 75
 DATE: 03/15/19
 REVISIONS TABLE FOR THIS ISSUE ONLY -
 STATUS: ST110B

UNIFORMS FOR THE INDUSTRY: ALL INFORMATION IS SUBJECT TO CHANGE WITHOUT NOTICE.
 METRIX IS A LEADER IN THE DESIGN AND MANUFACTURE OF HIGH QUALITY INDUSTRIAL PRODUCTS.
 MODEL: 5680-0020-0000
 XXX-4-000

UNIFORMS FOR THE INDUSTRY: ALL INFORMATION IS SUBJECT TO CHANGE WITHOUT NOTICE.
 METRIX IS A LEADER IN THE DESIGN AND MANUFACTURE OF HIGH QUALITY INDUSTRIAL PRODUCTS.
 MODEL: 5680-0020-0000
 XXX-4-000

TYPE: SPECIFICATIONS, 5680 SIGNAL CONDITIONER

UNIFORMS FOR THE INDUSTRY: ALL INFORMATION IS SUBJECT TO CHANGE WITHOUT NOTICE.
 METRIX IS A LEADER IN THE DESIGN AND MANUFACTURE OF HIGH QUALITY INDUSTRIAL PRODUCTS.
 MODEL: 5680-0020-0000
 XXX-4-000



SMART SWITCH SPECIFICATIONS:

FUNCTION: SMART SWITCH WITH ACCELERATION/VELOCITY/PROXIMITY INPUT AND 4-20mA CURRENT SOURCE OUTPUT. 4-20mA OUTPUT IS PROPORTIONAL TO INPUT WITHIN THE FULL-SCALE RANGE (SEE DATA SHEET OPTION CCCC)

INPUT (SENSOR) SENSITIVITY: SEE DATA SHEET OPTION FFFF

SIGNAL (SIG) OUTPUT: BUFFERED INPUT SIGNAL

CURRENT LOOP OUTPUT: 4-20mA DC CURRENT SOURCE

CURRENT OUTPUT ZERO ADJUSTMENT (4mA): FROM SOFTWARE

LOAD RESISTANCE: 25 TO 600 OHMS

FREQUENCY RESPONSE (3dB): 2Hz – 2kHz (VELOCITY), 2Hz – 5kHz (PROXIMITY), 2Hz-1.0kHz (ACCELERATION)

SIGNAL FILTER OPTIONS: SEE DATA SHEET OPTION D AND E

SENSOR OK: GREEN LED "ON" INDICATES SENSOR AND CABLE INTEGRITY

LCD DISPLAY: 4 DIGIT DISPLAY OF 4-20mA CURRENT AND RAW SIGNAL

SENSOR FAILURE: CAUSES CURRENT OUTPUT TO FALL BELOW 3.5mA, SENSOR OK LED TURN TO RED

ISOLATION: 500V, CIRCUIT TO CASE

TEMPERATURE LIMITS: -40°C TO +65°C

POWER: 24VDC ±10%

HAZARD RATING:
 NRTL US/C, Class I, Div 2, Grps A-D, T4 (increased safety)
 Class I, Zone 2, AEx ec nC IIC T4 Gc
 Class I, Zone 2, AEx ec nC IIC T4 Gc
 Class I, Zone 2, AEx ec nC IIC T4 Gc (increased safety)
 UKCA, Ex ec nC IIC T4 Gc (increased safety)

MOUNTING: FLAT BASE INSTALLED

WIRING DIAGRAM

Channel 1		Channel 2	
PIN	Channel 1	PIN	Channel 2
1	4-20mA+	1	4-20mA+
2	4-20mA-	2	4-20mA-
3	Raw signal out +	3	Raw signal out +
4	Raw signal out -	4	Raw signal out -
5	NC	5	NC
6	A/V+	6	A/V+
7	A/V-	7	A/V-
8	+	8	+
9	-	9	-
Dry Contacts			
10	Alert N.O.	Alert +	Solid State
11	Alert N.C.	Alert -	Solid State
12	Alert Common	Alert N.C.	Alert +
13	Danger N.O.	Danger +	Alert Common
14	Danger N.C.	Danger -	Alert +
15	Danger Common	Danger N.C.	Danger +
		15	Danger Common

TERMINAL BLOCK SCREWS
24 to 12 AWG
0.5 Nm TIGHTENING TORQUE

TERMINAL BLOCK SCREWS
26 to 16 AWG
0.25 Nm TIGHTENING TORQUE

<table border="1" style="width: 100%;"> <thead> <tr> <th colspan="2">REVISION HISTORY</th> </tr> <tr> <th>REV</th> <th>CH/DESCRIPTION</th> </tr> </thead> <tbody> <tr> <td>A</td> <td>RELEASE</td> </tr> <tr> <td>B</td> <td>ADDED UKCA INFO</td> </tr> </tbody> </table>	REVISION HISTORY		REV	CH/DESCRIPTION	A	RELEASE	B	ADDED UKCA INFO	<p>REV 07/27/20</p> <p>DATE 07/27/20</p> <p>DESIGNED BY A. WILSON</p> <p>APPROVED BY [Signature]</p> <p>SCALE (PLOT) 1/1</p> <p>MODEL ASSA-0228-00m</p> <p>DWG STATUS [Symbol]</p>
REVISION HISTORY									
REV	CH/DESCRIPTION								
A	RELEASE								
B	ADDED UKCA INFO								
<p>MASS 66.81g ± .75</p> <p>RESPONSIBILITY RESPONSIBLE FOR THIS ISSUE ONLY</p> <p>QTY 100</p>	<p>UNIT INCHES</p> <p>SCALE 4:1</p> <p>DATE 07/27/20</p> <p>PROJECT METRIX SMART SWITCH</p> <p>REV 07/27/20</p> <p>QTY 100</p> <p>DATE 07/27/20</p>								
<p>TABLE</p> <p>SPECIFICATIONS, SW6580 SMART SWITCH</p>	<p>REV 07/27/20</p> <p>DATE 07/27/20</p> <p>DESIGNED BY A. WILSON</p> <p>APPROVED BY [Signature]</p> <p>SCALE (PLOT) 1/1</p> <p>MODEL ASSA-0228-00m</p> <p>DWG STATUS [Symbol]</p>								

METRIX
 METRIX INC. • 11700 W. LOOP WEST • HOUSTON, TEXAS 77066 USA
 PHONE: 281.322.1125 • FAX: 281.322.1126 • WWW.METRIXINC.COM
 © 2022 METRIX INC. ALL RIGHTS RESERVED. METRIX AND THE METRIX LOGO ARE TRADEMARKS OF METRIX INC.

FIGURE NO. 13701201 REV B



WARNING:

CSA Equipment Installation Requirement per ordinary locations standards, C22.2/UL 61010-1:

Applicable for permanently connected equipment:

- a. A switch or circuit-breaker must be included in the installation;
- b. It must be suitably located and easily reached;
- c. It must be marked as the disconnecting device for the equipment
- d. Under normal operation, the BNC and USB must not be connected to any equipment

Equipment environment Ratings:

- a. Pollution Degree 3
- b. Input Voltage: 24 VDC +/- 10%, (Input power to Channel 1 only), Max Power: 4W
- c. Altitude 2000m or less
- d. Outdoor: installed in a minimum IP54 enclosure
- e. Temperature: 5580: -40° C to +85° C
SW5580: -40° C to +65° C
- f. Overvoltage Category II

If the equipment is used in a manner not specified by the manufacturer, the protection provided by the equipment may be impaired.

ENVIRONMENTAL INFORMATION

This electronic equipment was manufactured according to high quality standards to ensure safe and reliable operation when used as intended. Due to its nature, this equipment may contain small quantities of substances known to be hazardous to the environment or to human health if released into the environment. For this reason, Waste Electrical and Electronic Equipment (commonly known as WEEE) should never be disposed of in the public waste stream. The “Crossed-Out Waste Bin” label affixed to this product is a reminder to dispose of this product in accordance with local WEEE regulations. If you have questions about the disposal process, please contact Metrix Customer Service.

Note: Metrix is continuously improving our products. Please refer to our website to download the latest version of this datasheet.